



SPECIFICATION FOR LCD MODULE

Customer : _____
CustomerP/N _____
Model No. : GX034-30MB-A1
Version : V00
Date : 2022-08-05

Final Approval by Customer

| | | |
|---|-------------|--|
| LCM Machinery OK <input type="checkbox"/> | Checked By | |
| LCM Display OK <input type="checkbox"/> | Checked By | |
| LCM NG <input type="checkbox"/> LCM OK <input type="checkbox"/> | Approved By | |

ShenZhen BELIJ Confirmed :

| DESIGN | CHECK | APPROVAL |
|--------|-------|----------|
| | | |

联系人：岳爱福 15989334751 地址：深圳市光明区玉塘街道田寮社区田阔路15号三楼



LIST OF CONTENTS

| No. | CONTENTS | PAGE |
|-----|-----------------------------------|------|
| 1 | REVISION HISTORY | |
| 2 | GENERAL INFORMATION | |
| 3 | ABSOLUTE MAXIMUM RATINGS | |
| 4 | DC ELECTRICAL CHARACTERISTICS | |
| 5 | TIMING CHARACTERISTICS | |
| 6 | RESET TIMING | |
| 7 | EXTERNAL DIMENSIONS | |
| 8 | INTERFACE SIGNALS | |
| 9 | ELECTRO-OPTICAL CHARACTERISTICS | |
| 10 | RELIABILITY TEST CONDITIONS | |
| 11 | INSPECTION CRITERION | |
| 12 | PRECAUTINGS FOR USING LCD MODULES | |



深圳市高信技术有限公司

1-REVISION HISTORY

| Version | Date | Description | Revised By |
|---------|------------|--------------|------------|
| V00 | 2022-08-05 | First Issued | FLQ |
| | | | |
| | | | |
| | | | |
| | | | |
| | | | |
| | | | |
| | | | |



2 GENERAL INFORMATION

| Item | Specification | Unit |
|----------------------------|----------------------------|-------|
| LCD size 液晶面板尺寸 | 3.4 | inch |
| Display Mode 显示模式 | Normally Black | -- |
| Resolution 分辨率 | 800(RGB)x800 | Pixel |
| Pixel pitch 像素尺寸 | 36.5(H) x 109.5(V) | μm |
| Pixel Arrangement 像素排列 | RGB Vertical Stripe | |
| Viewing direction 视角 | Free | - |
| Module outline dimension | 94.9 (H)*96.95 (V)*2.22(D) | mm |
| LCD AA 液晶显示区域 | 87.6 (H)* 87.6 (V) | mm |
| TP VA 触摸可视区域 | - | mm |
| Colors 颜色深度 | 16.7M | - |
| Interface 接口类型 | MIPI | -- |
| Touch IC 触摸芯片 | - | -- |
| Surface hardness 表面硬度 | - | -- |
| 支持点数 | - | -- |
| Touch structure 触摸结构 | - | -- |
| Cover lens 盖板 | - | -- |
| Colors 颜色 | - | -- |
| Operating Temperature 工作温度 | -20℃~ +70℃ | -- |
| Storage Temperature 存储温度 | -25℃~ +75℃ | -- |
| 环保要求 | ROHS | -- |



3 ABSOLUTE MAXIMUM RATINGS

| Parameter | Symbol | Min | Max | Unit | Note |
|----------------------------|-----------|------|-----------|------|------|
| Power Supply voltage 1 | VCI~GND | -0.3 | +6.5 | V | |
| Power Supply voltage 2 | IOVCC~GND | -0.3 | +3.3 | V | |
| Logic Input Voltage Range | V_{IN} | -0.3 | IOVCC+0.3 | V | |
| Logic Output Voltage Range | V_O | -0.3 | IOVCC+0.3 | V | |
| Operating temperature | Topr | -20 | +70 | °C | |
| Storage temperature | Tstg | -25 | +75 | °C | |

* The absolute maximum rating values of this product are not allowed to be exceeded at any times. Should a module be used with any of the absolute maximum ratings exceeded, the characteristics of the module may not be recovered, or in an extreme case, the module may be permanently destroyed.

4 DC ELECTRICAL CHARACTERISTICS

4.1 Driving TFT LCD Panel

AGND = GND = 0V, Ta = 25°C

| Parameter | Symbol | Min | Typ | Max | Unit |
|-----------------------------------|----------|------------|-----|-----------|------|
| Supply voltage for analog circuit | VCI | 2.5 | 3.3 | 3.6 | V |
| Supply voltage for logic circuit | IOVCC | 1.65 | 1.8 | 3.3 | V |
| Input voltage 'H'level | V_{IH} | 0.7*IOVCC | — | IOVCC | V |
| Input voltage 'L'level | V_{IL} | GND | — | 0.3*IOVCC | V |
| Output voltage 'H'level | V_{OH} | 0.8*IOVCCI | — | IOVCC | V |
| Output voltage 'L'level | V_{OL} | GND | — | 0.2*IOVCC | V |

4.2 Backlight Characteristics

Ta = 25°C

| Item | Symbol | Min | Typ | Max | Unit | Condition |
|-----------------|--------|-------------------|------|-----|-------------------|-----------|
| Forward voltage | Vf | | 24.0 | | V | If=40 mA |
| LCM Luminance | LV | | 300 | — | cd/m ² | |
| Number of LED | - | 4X2 | | | Piece | - |
| Connection mode | S/P | 4Serial/2Parallel | | | - | - |

Using condition: constant current driving method If= 4×20mA (+/-10%)



5 TIMING CHARACTERISTICS

5.1 High Speed Mode-Clock Channel Timing

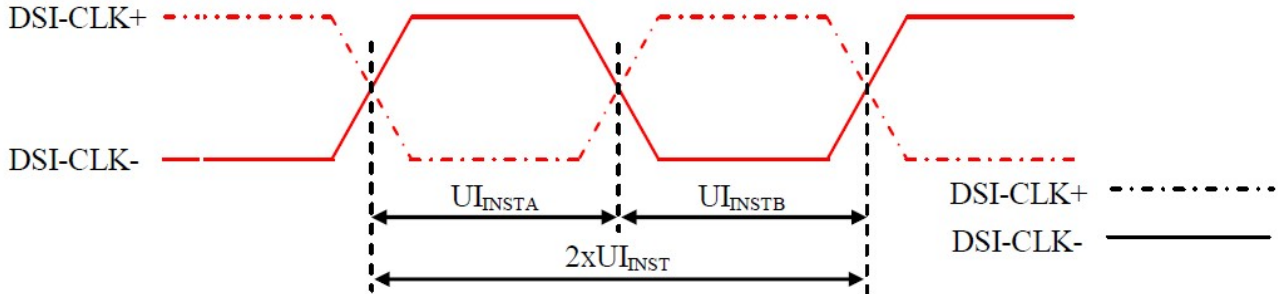

Figure 5.1.1 DSI Clock Channel Timing

| Signal | Symbol | Parameter | Min | Max | Unit |
|--------|--------------------------------------|-------------------------|---------------|------|------|
| CLKP/N | $2xUI_{INST}$ | Double UI instantaneous | 4 | 25 | ns |
| CLKP/N | UI_{INSTA}, UI_{INSTB} (Note 1) | UI instantaneous Half | 2 (Note 2) | 12.5 | ns |

Notes:

1. $UI = UI_{INSTA} = UI_{INSTB}$
2. Define the minimum value of 24 UI per Pixel, see Table 39.

Table 39: Limited Clock Channel Speed

| Data type | Two Lanes speed | Three Lanes speed | Four Lanes speed |
|---|-----------------|-------------------|------------------|
| Data Type = 00 1110 (0Eh), RGB 565, 16 UI per Pixel | 566 Mbps | 433 Mbps | 366 Mbps |
| Data Type = 01 1110 (1Eh), RGB 666, 18 UI per Pixel | 637 Mbps | 487 Mbps | 412 Mbps |
| Data Type = 10 1110 (2Eh), RGB 666 Loosely, 24 UI per Pixel | 850 Mbps | 650 Mbps | 550 Mbps |
| Data Type = 11 1110 (3Eh), RGB 888, 24 UI per Pixel | 850 Mbps | 650 Mbps | 550 Mbps |

5.2 High Speed Mode-Data Clock Channel Timing

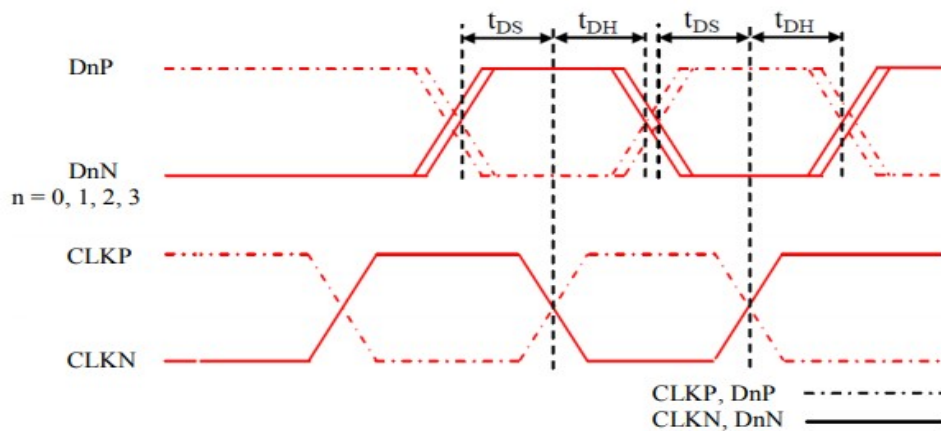

Figure 5.2.1 Data to Clock Channel Timing



| Signal | Symbol | Parameter | Min | Max |
|------------------|----------|--------------------------|---------|-----|
| DnP/N, n=0 and 1 | t_{DS} | Data to Clock Setup time | 0.15xUI | - |
| | t_{DH} | Clock to Data Hold Time | 0.15xUI | - |

5.3 High Speed Mode-Rising and Falling Timings

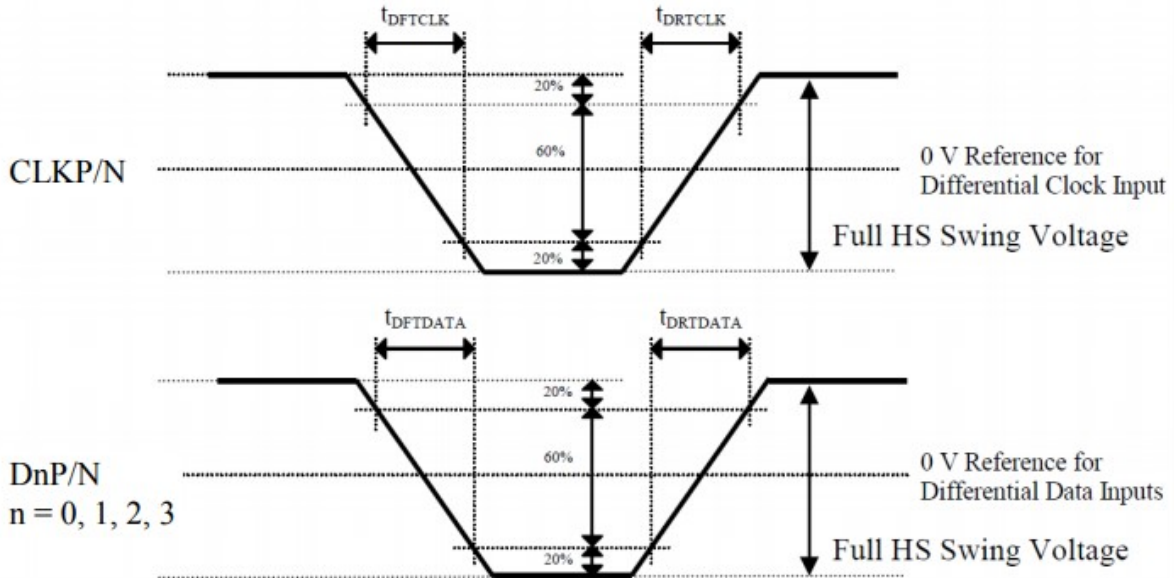

Figure 5.3.1 Rising and Falling Timings on Clock and Data channels

| Parameter | Symbol | Condition | Specification | | |
|----------------------------------|---------------|--------------------|---------------|-----|--------------|
| | | | Min | Typ | Max |
| Differential Rise Time for Clock | t_{DRTCLK} | CLKP/N | 150 ps | - | 0.3UI (Note) |
| Differential Rise Time for Data | $t_{DRTDATA}$ | DnP/N n=0 and 1 | 150 ps | - | 0.3UI (Note) |
| Differential Fall Time for Clock | t_{DFTCLK} | CLKP/N | 150 ps | - | 0.3UI (Note) |
| Differential Fall Time for Data | $t_{DFTDATA}$ | DnP/N n=0 and 1 | 150 ps | - | 0.3UI (Note) |

Note: The display module has to meet timing requirements, which are defined for the transmitter (MCU) on MIPI D-Phy standard.



5.4 VCI VDDI(IOVCC) Input power sequence

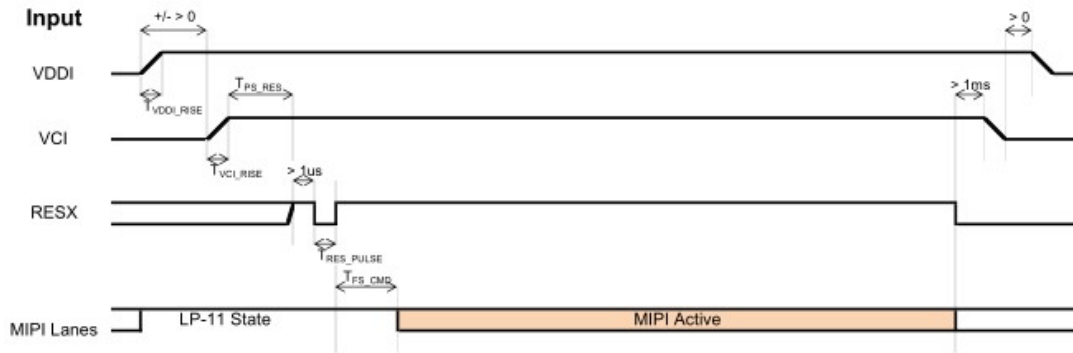

| Symbol | Characteristics | Min. | Typ. | Max. | Units |
|------------------|---------------------------|------|------|------|-------|
| T_{VDDI_RISE} | VDDI Rise time | 200 | - | - | us |
| T_{VCI_RISE} | VCI Rise time | 200 | - | - | us |
| T_{PS_RES} | VDDI/VCI on to Reset high | 5 | - | - | ms |
| T_{RES_PULSE} | Reset low pulse time | 10 | - | - | us |
| T_{FS_CMD} | Reset to first command | 10 | - | - | ms |

Figure 5.4.1 VCI/VDDI input power on/of sequence



6. Reset Timing

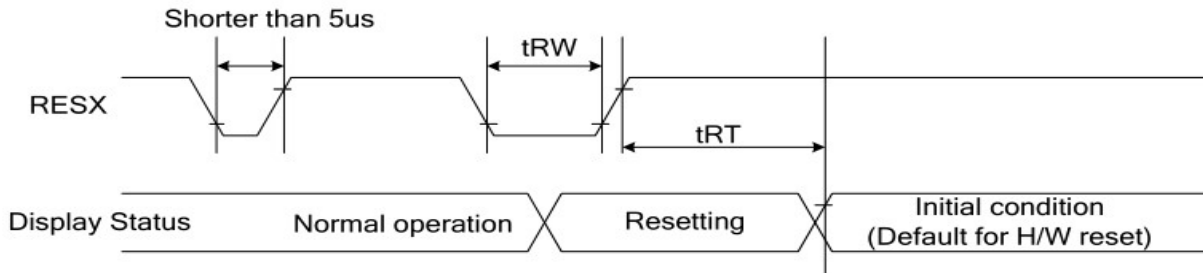

| Signal | Symbol | Parameter | Min | Max | Unit |
|--------|--------|----------------------|-----|----------------------------------|------|
| RESX | tRW | Reset pulse duration | 10 | | uS |
| | tRT | Reset cancel | | 5 (note 1,5) 120 (note 1,6,7) | mS |

Notes:

1. The reset cancel also includes required time for loading ID bytes, VCOM setting and other settings from EEPROM (or similar device) to registers.

This loading is done every time when there is HW reset cancel time (tRT) within 10 ms after a rising edge of RESX.

2. Spike due to an electrostatic discharge on RESX line does not cause irregular system reset according to the table below :

| RESX Pulse | Action |
|---------------------|----------------|
| Shorter than 5us | Reset Rejected |
| Longer than 9us | Reset |
| Between 5us and 9us | Reset starts |

3. During the Resetting period, the display will be blanked(The display is entering blanking sequence, which maximum time is 120 ms, when Reset

Starts at Sleep-Out status. The display remains the blank state in Sleep-In mode). Then return to Default condition for Hardware Reset

4. Spike Rejection also applies during a valid reset pulse as shown below :

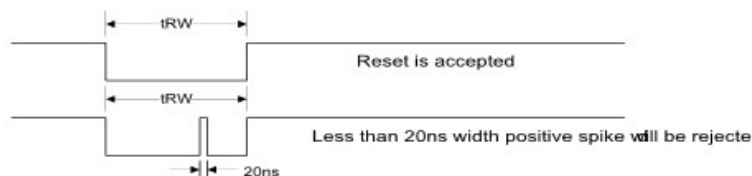

5. When Reset applied during Sleep-In Mode.

6. When Reset applied during Sleep-Out Mode

7. It is necessary to wait 10ms after releasing RESX before sending commands. Also Sleep Out command cannot be sent for 120 ms.



7. EXTERNAL DIMENSIONS

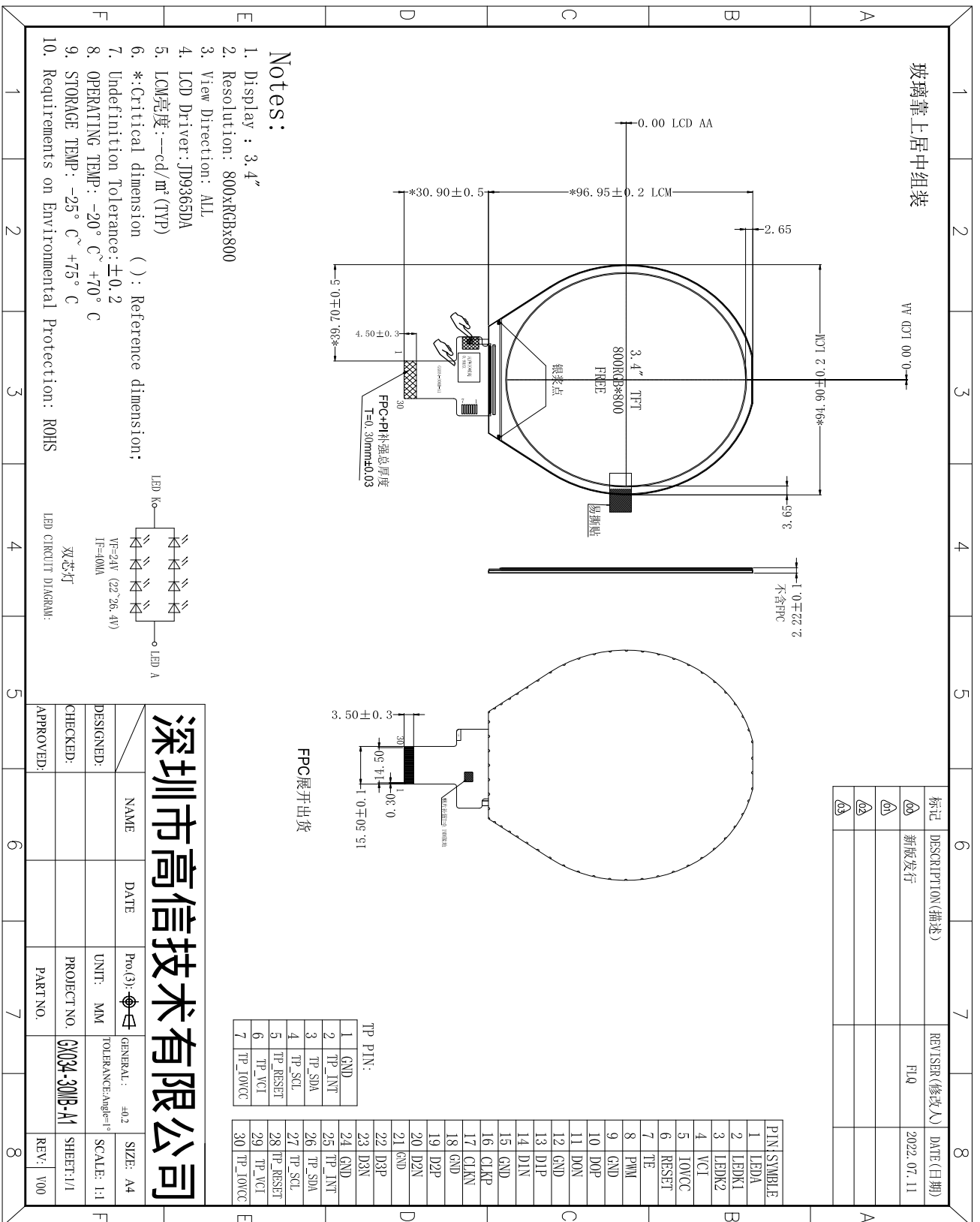

深圳市高信技术有限公司



8 INTERFACE SIGNAL

| Pin No. | Symbol | Description |
|---------|-----------|--|
| 1 | LEDA | LED backlight anode. |
| 2 | LEDK | LED backlight cathode. |
| 3 | LEDK | LED backlight cathode. |
| 4 | VCI | Power supply for the analog power |
| 5 | IOVCC | Power supply for the logic power and I/O circuit |
| 6 | RESET | Reset signal(low active) |
| 7 | TE | Tearing effect output |
| 8 | PWM | The PWM frequency output for LCD driver control. |
| 9 | GND | Power ground |
| 10 | MIPI_DP0 | MIPI-DSI data lane 0 positive input pin. |
| 11 | MIPI_DN0 | MIPI-DSI data lane 0 negative input pin. |
| 12 | GND | Power ground |
| 13 | MIPI_DP1 | MIPI-DSI data lane 1 positive input pin. |
| 14 | MIPI_DN1 | MIPI-DSI data lane 1 negative input pin. |
| 15 | GND | Power ground |
| 16 | MIPI_CLKP | MIPI-DSI data lane positive input pin. |
| 17 | MIPI_CLKN | MIPI-DSI data lane negative input pin. |
| 18 | GND | Power ground |
| 19 | MIPI_DP2 | MIPI-DSI data lane 2 positive input pin. |
| 20 | MIPI_DN2 | MIPI-DSI data lane 2 negative input pin. |
| 21 | GND | Power ground |
| 22 | MIPI_DP3 | MIPI-DSI data lane 3 positive input pin. |
| 23 | MIPI_DN3 | MIPI-DSI data lane 3 negative input pin. |
| 24 | GND | Power ground |
| 25 | TP_INT | INT pin for CTP |
| 26 | TP_SDA | SDA pin for CTP |
| 27 | TP_SCL | SCL pin for CTP |
| 28 | TP_RESET | Reset pin for TP |
| 29 | TP_VCI | VCI pin for CTP |
| 30 | TP_IOVCC | IOVCC pin for CTP |



9. ELECTRO-OPTICAL CHARACTERISTICS

| Item | Symbol | Condition | Min | Typ | Max | Unit | Note |
|-------------------------------|------------------|--|-------|------|-------|-----------------|------|
| Transmittance (w/o polarizer) | T% | $\theta=0^\circ$ $T_a=25^\circ\text{C}$ | 4.7 | 5.5 | - | % | 1 |
| Contrast ratio | Cr | | 1000 | 1200 | - | - | 3 |
| Response time | $T_{on}+T_{off}$ | | - | 30 | 35 | ms | 4 |
| Surface Luminance | LV | | -- | 300 | - | cd/m^2 | 2 |
| Color Gamut | | $\theta=0^\circ$ | 65 | 70 | | % | |
| Viewing angle range | H or V er | Θ_{x+} | - | 85 | - | deg | 5 |
| | | Θ_{x-} | - | 85 | - | deg | |
| | | Θ_{y+} | - | 85 | - | deg | |
| | | Θ_{y-} | - | 85 | - | deg | |
| CIE(x,y) chromaticity | Red | x | -0.03 | | +0.03 | - | 6 |
| | | y | | | | - | |
| | Green | x | | | | - | |
| | | y | | | | - | |
| | Blue | x | | | | - | |
| | | y | | | | - | |
| White | x | - | | | | | |
| | y | - | | | | | |

Note 1. Ambient condition: $25^\circ\text{C}\pm 2^\circ\text{C}$, $60\pm 10\%\text{RH}$, under 10 Lux in the darkroom.

Note 2. Measure device: BM-7A (TOPCON), viewing cone= 2°

Lv = Average Surface Luminance with all white pixels (P1,P2,P3,P4,P5)

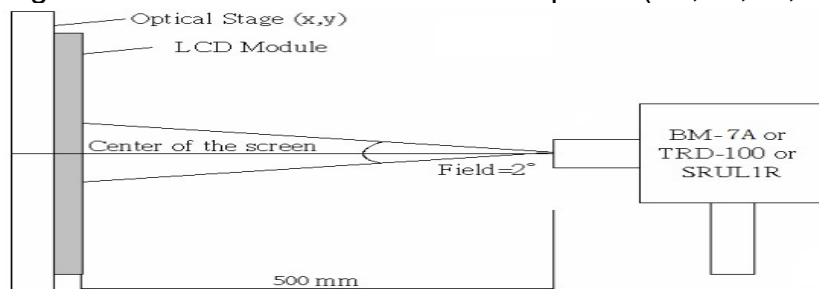

Note 3. Definition of Contrast Ratio:

$$CR = \frac{\text{Average Surface Luminance with all black pixels (P1,P2,P3,P4,P5)}}{\text{Average Surface Luminance with all white pixels (P1,P2,P3,P4,P5)}}$$



深圳市高信技术有限公司

Note 4. Definition of Response Time (T_{on} , T_{off}), The response time is defined as the time interval between the 10% and 90% amplitudes.

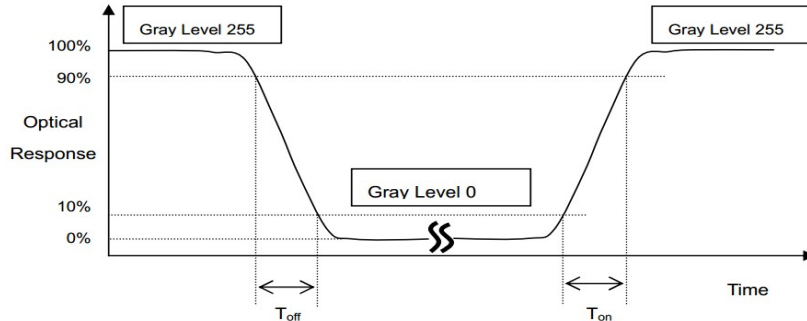

Note 5. Definition of view angle(θ , ψ):

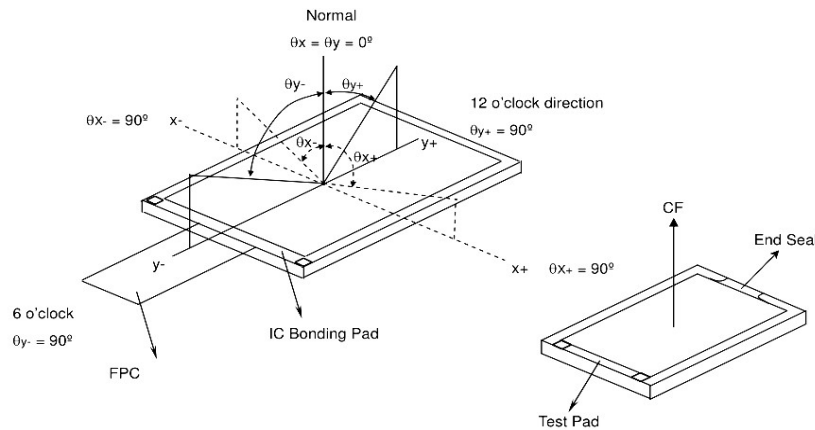

Note 6. The LCD module should be stabilized at a given temperature for 20 minutes to avoid abrupt temperature change during measuring. In order to stabilize the luminance, the measurement should be executed after lighting Backlight for 20 minutes in a windless room. Measuring method for Contrast ratio, surface luminance, Luminance uniformity, CIE(x,y) chromaticity.

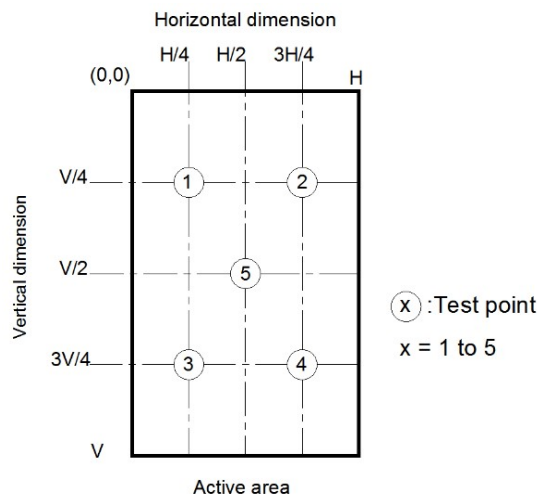

Light spot size $\varnothing=7\text{mm}$, 500mm distance from the LCD surface to detector lens measurement instrument is TOPCON's luminance meter BM-7



10 RELIABILITY TEST

Reliability test conditions (Polarizer characteristics null)

| No. | Items | Condition | Inspection after test |
|-----|--------------------------------------|---|--|
| 1 | High Temperature Storage | T =75°C for 48 hr | Inspection after 4 hours storage at room temperature, the sample shall be free from defects: 1.Air bubble in the LCD 2.Sealleak; 3.Non-display; 4.missing segments; 5.Glass crack; 6.Current Idd is twice higher than initial value. |
| 2 | Low Temperature Storage | T = -25°C for 48 hr | |
| 3 | High Temperature Operating | T = 70°C for 48 hr | |
| 4 | Low Temperature Operating | T = -20°Cfor 48 hr (But no condensation of dew) | |
| 5 | High Temp. and High Humidity Storage | T = 60°C /90% for 48 hr (But no condensation dew) | |
| 6 | Thermal Shock | -20°C~25~60°C×10cycles (30min.) (5min.) (30min.) | |
| 7 | Dropping test (non-operation) | Drop to the ground from 76cm height, one time, every side of carton. (Packing condition) | |
| 8 | Packing Vibration (non-operation) | Frequency: 10Hz~55Hz~10Hz Amplitude: 1.0mm, X, Y, Z direction for total 3hours (Packing condition) | |
| 9 | ESD | Voltage:±6KV R: 330Ω C: 150pF Air discharge, 10time | |

Note:

- (1)The test samples should be applied to only one test item.
- (2)Sample size for each test item is 5~10pcs.
- (3)In case of malfunction defect caused by ESD damage, if it would be recovered to normal state after resetting, it would be judge as a good part.
Using ionizer(an antistatic blower) is recommended at working area in order to reduce electro-static voltage.
When removing protection film from LCM panel, peel off the tag slowly (recommended more than one second) while blowing with ionizer toward the peeling face to minimize ESD which may damage electrical circuit.
- (4) Please use automatic switch testing mode when test operating mode.



11 INSPECTION CRITERION

This specification is made to be used as the standard acceptance/rejection criteria for Normal LCM Product.

1 Sample plan

Sampling plan according to GB/T2828.1-2003/ISO 2859-1: 1999 and ANSI/ASQC Z1.4-1993, normal level 2 and based on:

Major defect: AQL 0.65

Minor defect: AQL 1.0

2. Inspection condition

Viewing distance for cosmetic inspection is about 30cm with bare eyes, and under an environment of 20~40W light intensity, all directions for inspecting the sample should be within 45° against perpendicular line. (Normal temperature 20~25°C and normal humidity 60±15%RH).

3. Definition of inspection zone in LCD.

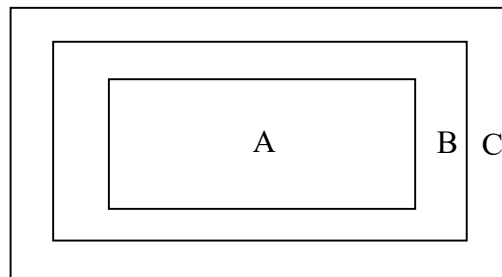

Zone A: character/Digit area

Zone B: viewing area except Zone A (Zone A + Zone B=minimum Viewing area)

Zone C: Outside viewing area (invisible area after assembly in customer's product)

Fig.1 Inspection zones in an LCD.

Note: As a general rule, visual defects in Zone C are permissible, when it is no trouble for quality and assembly of customer's product.

4. Standards of inspection items

4.1 Major Defect

| Item No | Items to be inspected | Inspection Standard | Classification of defects |
|---------|------------------------|--|---------------------------|
| 4.1.1 | All functional defects | 1.No display | Major |
| | | 2.Display abnormally | |
| | | 3.Missing vertical, horizontal segment | |
| | | 4.Short circuit | |
| | | 5. Back-light no lighting, flickering and abnormal lighting. | |



深圳市高信技术有限公司

| | | | |
|-------|-------------------|--|--|
| 4.1.2 | Missing | Missing component | |
| 4.1.3 | Outline dimension | Overall outline dimension beyond the drawing is not allowed. | |
| 4.1.4 | linearity | No more than 1.5% | |

4.2 Cosmetic Defect

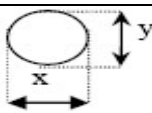
| Item No | Items to be inspected | Inspection Standard | | | Classification of defects | |
|-------------------------|---|---|----------------|--------|---------------------------|--------|
| 4.2.1 | Clear Spots Black and white Spot defect Pinhole, Foreign Particle, polarizer Dirt | For dark/white spot, size Φ is defined as $\Phi = (x + y)/2$ | | | Minor | |
| | |  | | | | |
| | | 1 | | | | |
| | | Zone | Acceptable Qty | | | |
| | | Size(mm) | A | B | | C |
| | | $\Phi \leq 0.15$ | Ignore | | | Ignore |
| | | $0.15 < \Phi \leq 0.20$ | 2 | | | |
| | $0.20 < \Phi \leq 0.30$ | 1 | | | | |
| | $\Phi > 0.30$ | 0 | | | | |
| | Clear Spots TP Dirt | 2 | | | Minor | |
| | | Zone | Acceptable Qty | | | |
| | | Size(mm) | A | B | | C |
| | | $\Phi \leq 0.15$ | Ignore | | | Ignore |
| | | $0.15 < \Phi \leq 0.20$ | 2 | | | |
| | | $0.20 < \Phi \leq 0.30$ | 1 | | | |
| | | $\Phi > 0.30$ | 0 | | | |
| | Dim Spots Circle shaped and dim edged defects | 3 | | | Minor | |
| | | Zone | Acceptable Qty | | | |
| Size(mm) | | A | B | C | | |
| $\Phi \leq 0.2$ | | Ignore | | Ignore | | |
| $0.20 < \Phi \leq 0.40$ | | 2 | | | | |
| $0.40 < \Phi \leq 0.60$ | | 1 | | | | |
| $\Phi > 0.60$ | | 0 | | | | |



深圳市高信技术有限公司

| Item No | Items to be inspected | Inspection Standard | | | | Classification of defects | |
|---------------|--|--|----------------------|----------------|--------|---------------------------|--------|
| 4.2.2 | Line defect Black line, White line, Foreign material on polarizer | Size(mm) | | Acceptable Qty | | Minor | |
| | | L(Length) | W(Width) | Zone | | | |
| | | | | A | B | | C |
| | | Ignore | $W \leq 0.05$ | Ignore | Ignore | | |
| | | $L \leq 5.0$ | $0.05 < W \leq 0.08$ | 2 | | | |
| | | | $W > 0.08$ | 0 | | | |
| 4.2.2 | Foreign material on TP film | The line can be seen after mobile phone in the operating condition: | | | | Minor | |
| | | Size(mm) | | Acceptable Qty | | | |
| | | L(Length) | W(Width) | Zone | | | |
| | | | | A | B | | C |
| | | Ignore | $W \leq 0.05$ | Ignore | Ignore | | |
| | | $L \leq 5.0$ | $0.05 < W \leq 0.08$ | 3 | | | |
| | $W > 0.08$ | 0 | | | | | |
| 4.2.3 | Dim line defect Polarizer scratch TP film scratch | If the scratch can be seen after mobile phone cover assembling or in the operating condition, judge by the line defect of 4.2.2. If the scratch can be seen only in non-operating condition or some special angle, judge by the following. | | | | Minor | |
| | | Size(mm) | | Acceptable Qty | | | |
| | | L(Length) | W(Width) | Zone | | | |
| | | | | A | B | | C |
| | | Ignore | $W \leq 0.03$ | Ignore | Ignore | | |
| | | $5.0 < L \leq 10.0$ | $0.03 < W \leq 0.05$ | 2 | | | |
| $L \leq 5.0$ | $0.05 < W \leq 0.08$ | 1 | | | | | |
| | $W > 0.08$ | 0 | | | | | |
| 4.2.4 | Polarize Air bubble | Air bubbles between glass & polarizer | | | | Minor | |
| | | Zone | | Acceptable Qty | | | |
| | | Size(mm) | | A | B | | C |
| | | $\Phi \leq 0.20$ | | Ignore | | | Ignore |
| | | $0.20 < \Phi \leq 0.3$ | | 2 | | | |
| $\Phi > 0.30$ | | 0 | | | | | |

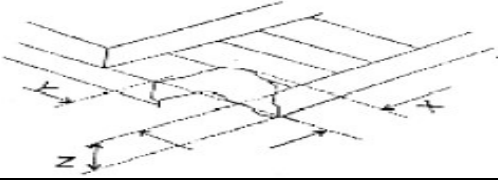
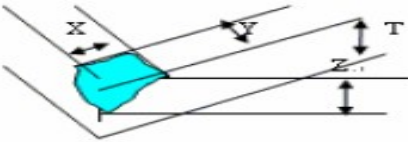
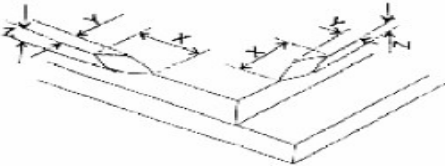
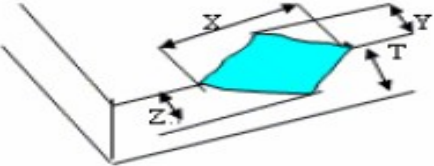
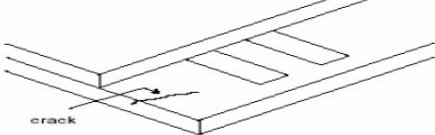

| Item No | Items to be inspected | Inspection Standard | Classification of defects | | | | | | |
|--|-----------------------|--|---------------------------|--------------------------------|-----------|-----------|------|--------------------------------|-----------|
| 4.35 | Glass defect | (i) Chips on corner A:LCD Glass defect  | Minor | | | | | | |
| | | <table border="1"> <tr> <td>X(mm)</td> <td>Y(mm)</td> <td>Z(mm)</td> </tr> <tr> <td>≤3.0</td> <td>≤3.0</td> <td>Disregard</td> </tr> </table> | | X(mm) | Y(mm) | Z(mm) | ≤3.0 | ≤3.0 | Disregard |
| | | X(mm) | | Y(mm) | Z(mm) | | | | |
| | | ≤3.0 | | ≤3.0 | Disregard | | | | |
| | | Notes: S=contact pad length Chips on the corner of terminal shall not be allowed to extend into the ITO pad or expose perimeter seal. B:TP Glass defect  | | | | | | | |
| | | <table border="1"> <tr> <td>X(mm)</td> <td>Y(mm)</td> <td>Z(mm)</td> </tr> <tr> <td>≤3.0</td> <td>≤3.0</td> <td>Disregard</td> </tr> </table> | | X(mm) | Y(mm) | Z(mm) | ≤3.0 | ≤3.0 | Disregard |
| | | X(mm) | | Y(mm) | Z(mm) | | | | |
| | | ≤3.0 | | ≤3.0 | Disregard | | | | |
| | | (ii) Usual surface cracks A:LCD Glass defect  | | | | | | | |
| | | <table border="1"> <tr> <td>X(mm)</td> <td>Y(mm)</td> <td>Z(mm)</td> </tr> <tr> <td>≤3.0</td> <td><Inner border line of the seal</td> <td>Disregard</td> </tr> </table> | | X(mm) | Y(mm) | Z(mm) | ≤3.0 | <Inner border line of the seal | Disregard |
| | | X(mm) | | Y(mm) | Z(mm) | | | | |
| | | ≤3.0 | | <Inner border line of the seal | Disregard | | | | |
| B:TP Glass defect  | | | | | | | | | |
| <table border="1"> <tr> <td>X(mm)</td> <td>Y(mm)</td> <td>Z(mm)</td> </tr> <tr> <td>≤6.0</td> <td><2.0</td> <td>Disregard</td> </tr> </table> | X(mm) | Y(mm) | Z(mm) | ≤6.0 | <2.0 | Disregard | | | |
| X(mm) | Y(mm) | Z(mm) | | | | | | | |
| ≤6.0 | <2.0 | Disregard | | | | | | | |
| (iii) Crack Cracks tend to break are not allowed.  | | | | | | | | | |



12 PRECAUTIONS FOR USE OF LCD MODULES

1. Handling Precautions

- (1) The display panel is made of glass and polarizer. As glass is fragile. It tends to become or chipped during handling especially on the edges. Please avoid dropping or jarring. Do not subject it to a mechanical shock by dropping it or impact.
- (2) If the display panel is damaged and the liquid crystal substance leaks out, be sure not to get any in your mouth. If the substance contacts your skin or clothes, wash it off using soap and water.
- (3) Do not apply excessive force to the display surface or the adjoining areas since this may cause the color tone to vary. Do not touch the display with bare hands. This will stain the display area and degraded insulation between terminals (some cosmetics are determined to the polarizer).
- (4) The polarizer covering the display surface of the LCD module is soft and easily scratched. Handle this polarizer carefully. Do not touch, push or rub the exposed polarizers with anything harder than an HB pencil lead (glass, tweezers, etc.). Do not put or attach anything on the display area to avoid leaving marks on. Condensation on the surface and contact with terminals due to cold will damage, stain or dirty the polarizer. After products are tested at low temperature they must be warmed up in a container before coming is contacting with room temperature air.
- (5) If the display surface becomes contaminated, breathe on the surface and gently wipe it with a soft dry cloth. If it is heavily contaminated, moisten cloth with one of the following solvents
 - Isopropyl alcohol
 - Ethyl alcoholDo not scrub hard to avoid damaging the display surface.
- (6) Solvents other than those above-mentioned may damage the polarizer. Especially, do not use the following.
 - Water
 - Ketone
 - Aromatic solventsWipe off saliva or water drops immediately, contact with water over a long period of time may cause deformation or color fading. Avoid contacting oil and fats.
- (7) Exercise care to minimize corrosion of the electrode. Corrosion of the electrodes is accelerated by water droplets, moisture condensation or a current flow in a high-humidity environment.
- (8) Install the LCD Module by using the mounting holes. When mounting the LCD module make sure it is free of twisting, warping and distortion. In particular, do not forcibly pull or bend the IO cable or the backlight cable.
- (9) Do not attempt to disassemble or process the LCD module.
- (10) NC terminal should be open. Do not connect anything.
- (11) If the logic circuit power is off, do not apply the input signals.



深圳市高信技术有限公司

- (12) Electro-Static Discharge Control, Since this module uses a CMOS LSI, the same careful attention should be paid to electrostatic discharge as for an ordinary CMOS IC. To prevent destruction of the elements by static electricity, be careful to maintain an optimum work environment.
- Before remove LCM from its packing case or incorporating it into a set, be sure the module and your body have the same electric potential. Be sure to ground the body when handling the LCD modules.
 - Tools required for assembling, such as soldering irons, must be properly grounded. Make certain the AC power source for the soldering iron does not leak. When using an electric screwdriver to attach LCM, the screwdriver should be of ground potentiality to minimize as much as possible any transmission of electromagnetic waves produced sparks coming from the commutator of the motor.
 - To reduce the amount of static electricity generated, do not conduct assembling and other work under dry conditions. To reduce the generation of static electricity be careful that the air in the work is not too dried. A relative humidity of 50%-60% is recommended. As far as possible make the electric potential of your work clothes and that of the work bench the ground potential
 - The LCD module is coated with a film to protect the display surface. Exercise care when peeling off this protective film since static electricity may be generated
- (13) Since LCM has been assembled and adjusted with a high degree of precision, avoid applying excessive shocks to the module or making any alterations or modifications to it.
- Do not alter, modify or change the shape of the tab on the metal frame.
 - Do not make extra holes on the printed circuit board, modify its shape or change the positions of components to be attached.
 - Do not damage or modify the pattern writing on the printed circuit board.
 - Absolutely do not modify the zebra rubber strip (conductive rubber) or heat seal connector.
 - Except for soldering the interface, do not make any alterations or modifications with a soldering iron.
 - Do not drop, bend or twist LCM.

2. Storage precautions

- 2.1 When storing the LCD modules, avoid exposure to direct sunlight or to the light of fluorescent lamps.
- 2.2 The LCD modules should be stored under the storage temperature range. If the LCD modules will be stored for a long time, the recommend condition is:
- Temperature : 0℃ ~ 40℃ Relatively humidity: ≤80%
- 2.3 The LCD modules should be stored in the room without acid, alkali and harmful gas.
- 2.4 The LCD modules should be no falling and violent shocking during transportation, and also should avoid excessive press, water, damp and sunshine.

----- END